

Bottlecap Bruce

Surgical Mask

Expansion Pack



1

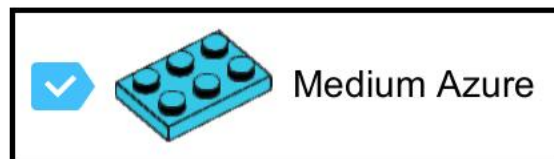
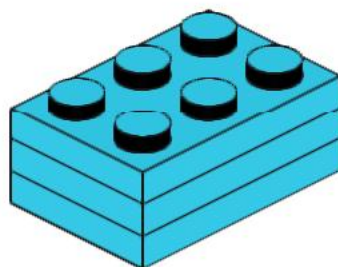
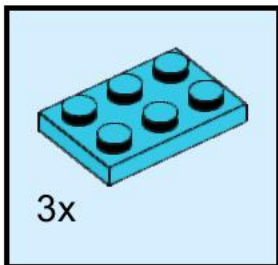

2

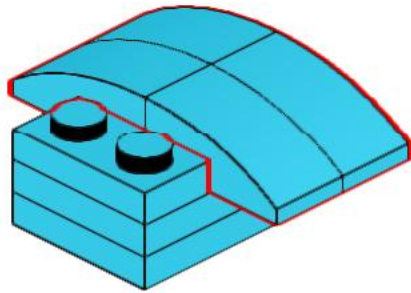
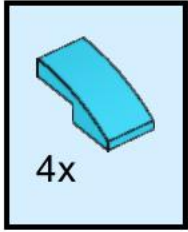

3

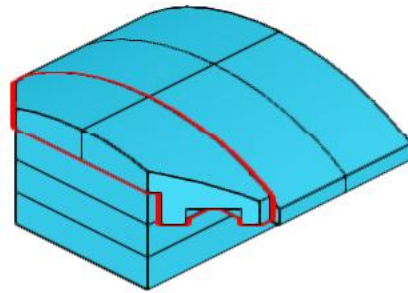
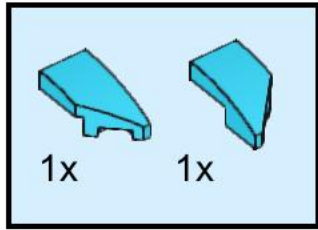

4

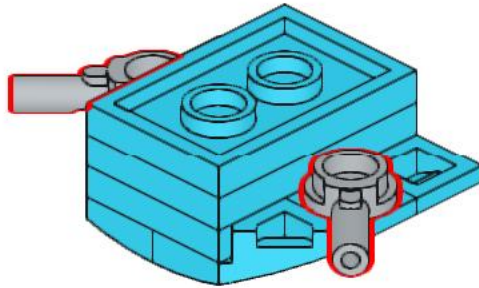

5

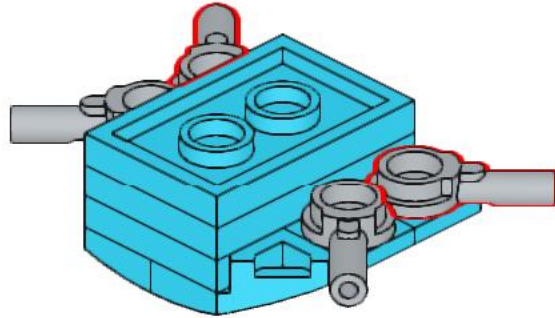

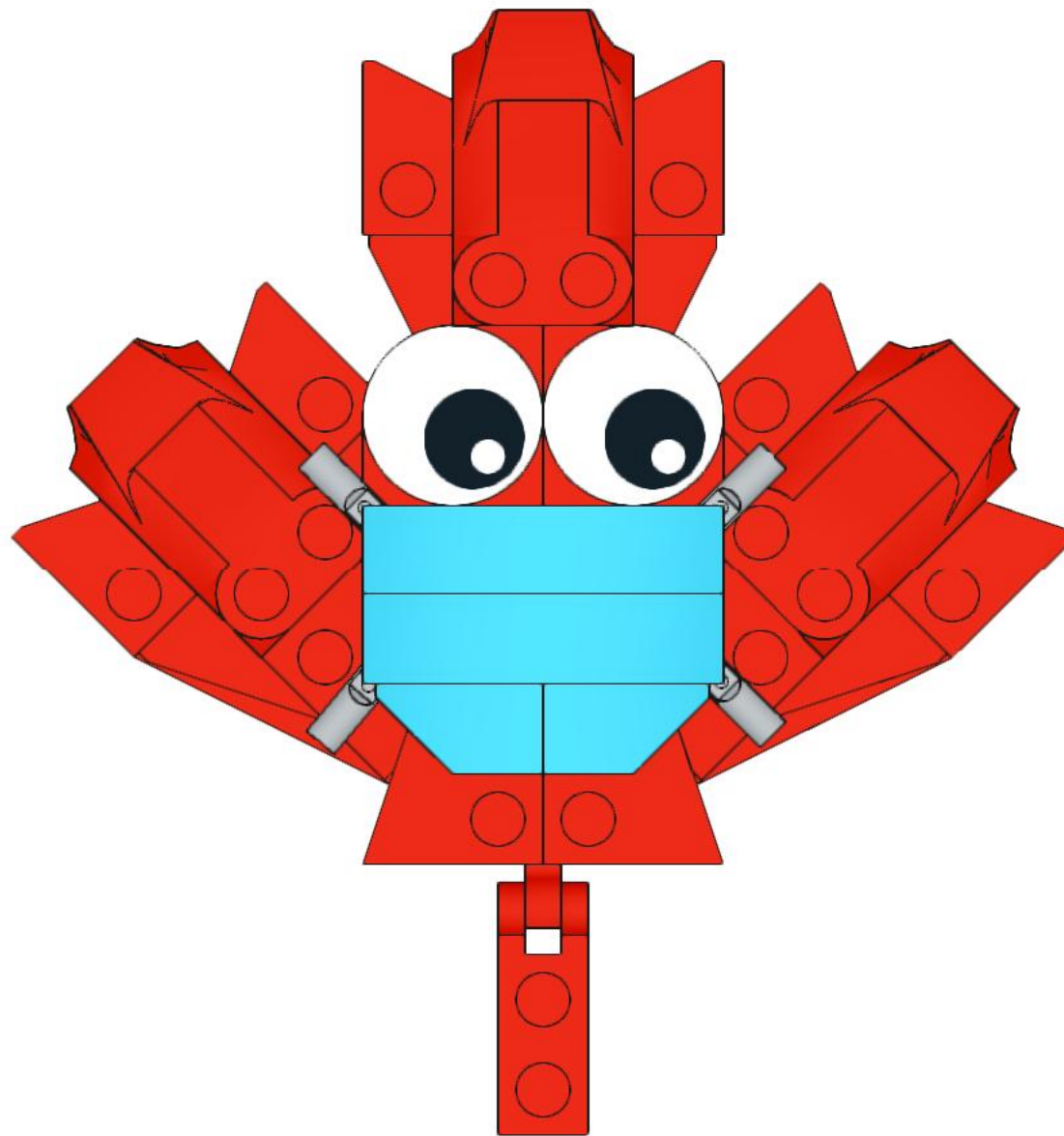



4x
32828, 86

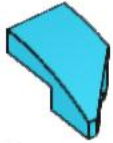

1x
29120, 156

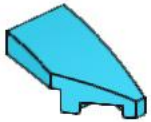

1x
29119, 156

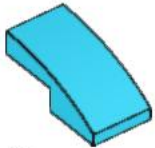

4x
11477, 156

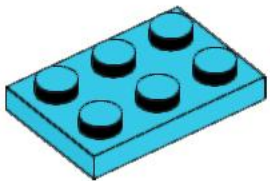

3x
3021, 156